

SOLO *SERIES*
USER MANUAL v2.0

What's Included

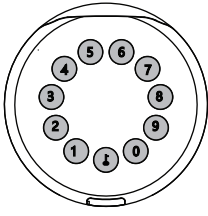

1 x Solo LockBox

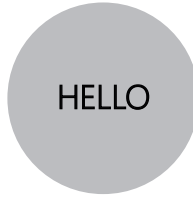

1 x HELLO Card

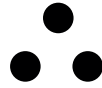

3 x Screw Cap



3 x Mounting Screws

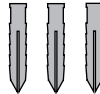

3 x Screws Anchors



1 x Reset Tool

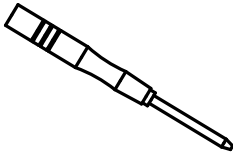

Screw Driver x 1

What are the differences

- >1. OTA upgrade: Support remote software upgrade
- >2. App: Simplified user interface / features

Specification

Model	Solo
Material	Body Zinc Alloy, SUS304
Battery	4 x AAA Alkaline Battery
Unlock Mechanism	Bluetooth, PIN Code, App
Jump Start	USB-C

Front

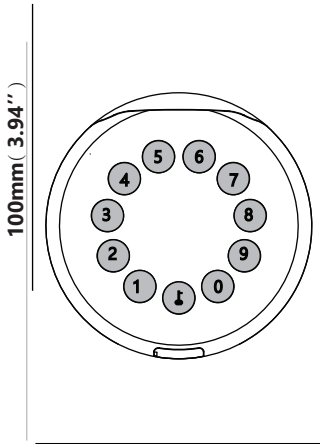

Inside

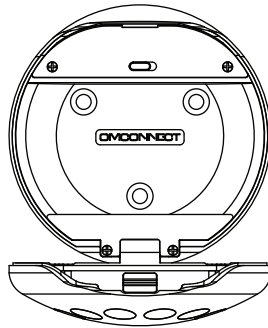

Back

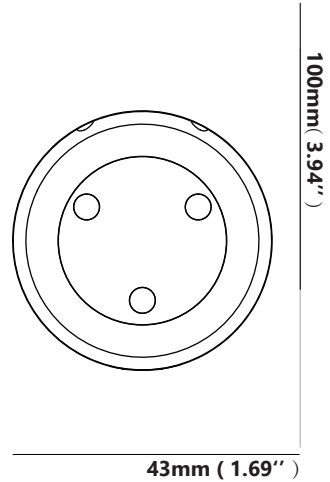

100mm (3.94")

Features

Lock&Unlock



Administrator Unlock

Set a Master Administrator PIN for Unlocking, settings, operations etc. and only the administrator could change the administrator PIN code.



Anti-peeping

Add up to 10 digits before and after PIN code to intensify your PINs.



User Unlock

This LockBox allows to add up to 100 user PIN codes for your family, friends and visitors.



Auto Locking

If there are no opening motions in 10 seconds the box will be automatically locked.

Mobile Control



Bluetooth one-touch unlock

With your Mobile you could unlock the LockBox by tapping the "🔒" on the App.



Offline Unlock

You could generate offline code through mobile App, for scheduled access, parcel delivery, housekeeping, etc.



Mobile Administrator

Set Administrator PIN Codes from your Mobile to unlock, add users, delete users, etc.



OTA Upgrade

Upgrade online, Fix bugs, Update functions and optimize user experience.

Battery



Battery Life

4 AAA batteries, the life cycle will be more than 12 months, please use good batteries.



Low Battery

When the battery runs out of power, system will remind you to replace the batteries.



Low Consumption

BLE broadcasting turns to sleep mode if no operations.

Emergency



Jump Start

When the power is down and use USB-C to jump start the lock and get it unlocked



System Lockdown

The lock will be lockdown for 5 minutes if continuously enter wrong PINs for 5 times.

Quick Start

Step 1 > Install Battery

>1. Remove the battery cover

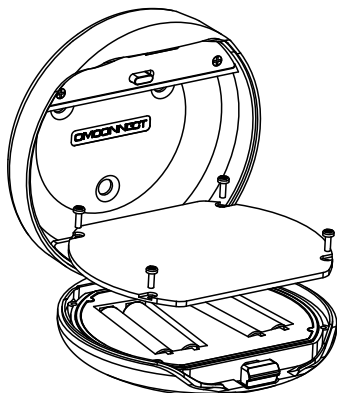

>2. Put 4 AAA batteries into the battery dock.

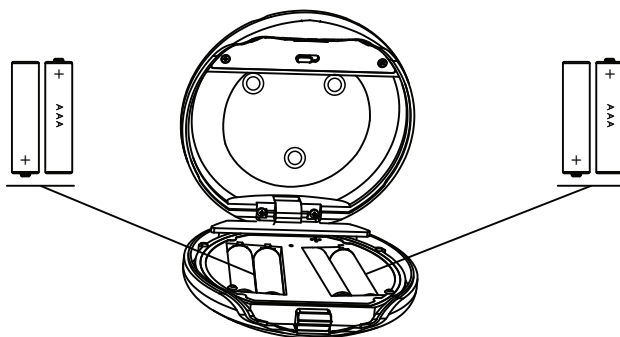

Step 2>Download Mobile App

>1. Scan QR Code below and download the App and turn on your mobile Bluetooth



Step 3>Add Device

>1. Go to App Home page, click Add Device or click "+" on the upper right.

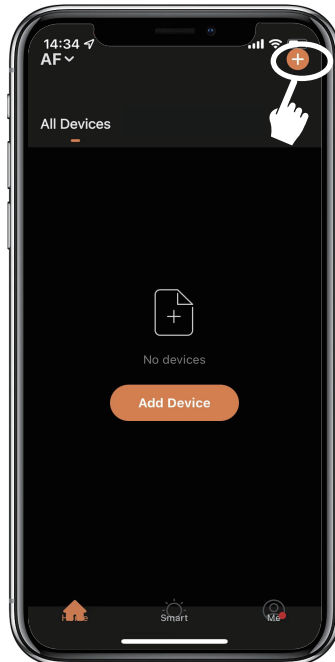

Activate Bluetooth to enter pairing mode

- > **2.** Press **⏻** +9+ **⏻** and enter Admin password + **⏻** , when the light slowly blinks in blue the KeyBox is ready to pair.

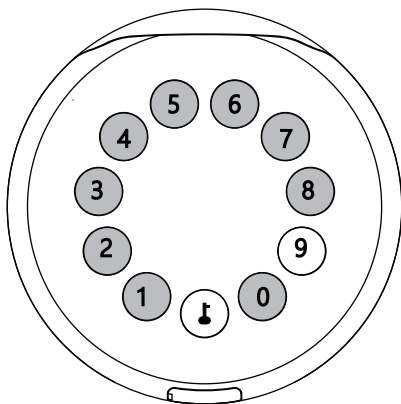

>3. You will see the detected device and click "Go to add".

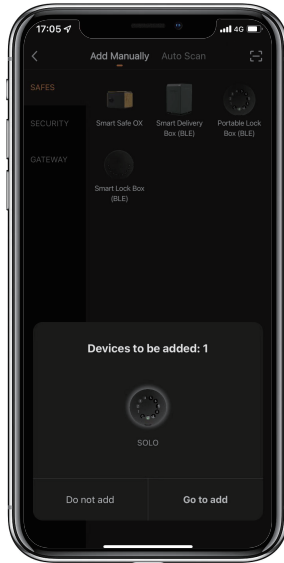

>4. Connecting, you need to wait for few seconds to let it finish.



>5. Device added



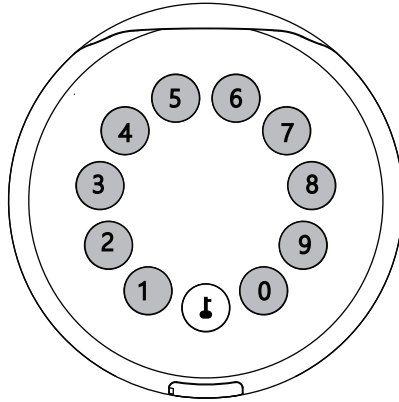

Step 4>Change Admin Password-Initial Admin Password:123456

>1. Press  and hold for 3 beeps



>2. Right after the 3 beeps please key in:

Initial Admin code 123456 +  +new admin code+  +new admin code again + , when you hear a long beep with green light, the new admin password has been set.

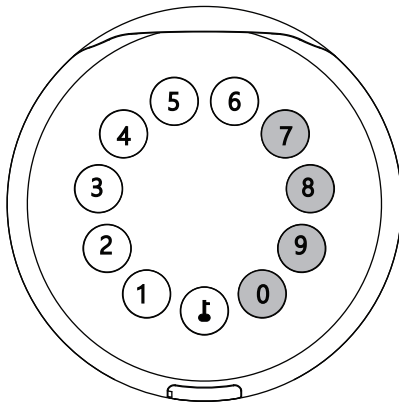

Mechanical Instructions

Password & Factory Mode:

1. Password Length

☒ Password must be 6 digits (no more no less)

2. Add User Password

☒ Tap **⏻** + 0 + **⏻** until the blue light blinks

>. Enter admin password + **⏻**

>. Enter new user password + **⏻**

>. Enter new user password again and press **⏻**

>. When the **⏻**(Enter button) blinks in green, user password has been set.

3. Delete User Password

☒ Tap **⏻** + 2 + **⏻** until the blue light blinks

>. Enter admin password and press **⏻**

>. Enter the user password you wish to delete and press **⏻**

>. Enter the user password again and press **⏻**

>. When the **⏻** (Enter button) blinks in green the password has been deleted.

4. Delete All User Password

☒ Tap **⏻** + 00000 + **⏻** until the blue light blinks

>. Enter admin password and press **⏻**

>. When the **⏻** (Enter button) blinks in green, all user passwords have been deleted.

5. Virtual digits-Anti Peeping

☒ Add any digits before and after the correct password the LockBox unlock as always

6. System Lockdown

☒ LockBox will Lockdown for 5 minutes if entering wrong password continuously 5 times.

7. Reset Factory Mode

☒ Use the reset tool press and hold the reset button for 5 seconds until a long beep.

Bluetooth broadcasting & re-connecting:

☒ Bluetooth will turn to sleep mode and lights out if no operations within 1 minute.

☒ Touch any key to activate the Bluetooth, LockBox will get reconnected again with App.

App Instructions

How to unlock:

- You will see all devices on the home page.
- Tap the Smart Lock Box to start operating.



- Swipe the  to the right to unlock.

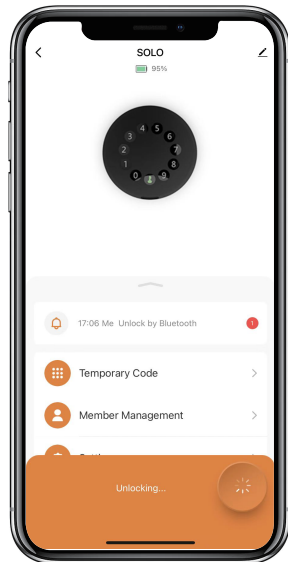
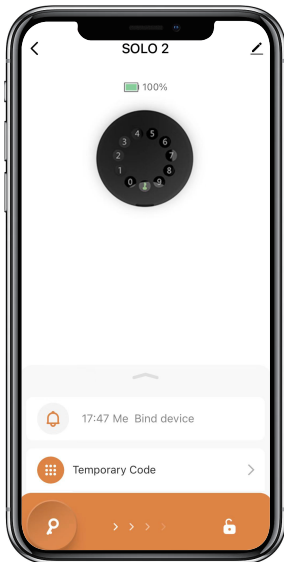

How to get Temporary code:

☒ Tap “Temporary Code”

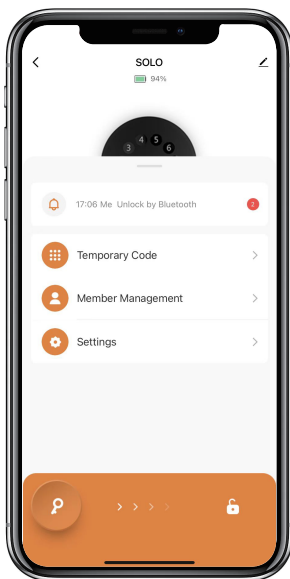

☒ Tap “Obtain Password” to get Dynamic code which is valid for 5 minutes.

☒ Tap “OK” to confirm and also can Tap “Share” to share this code with family or friend.

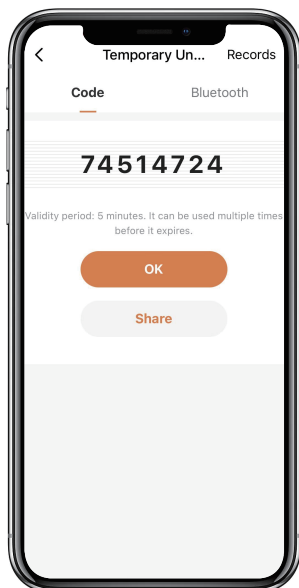
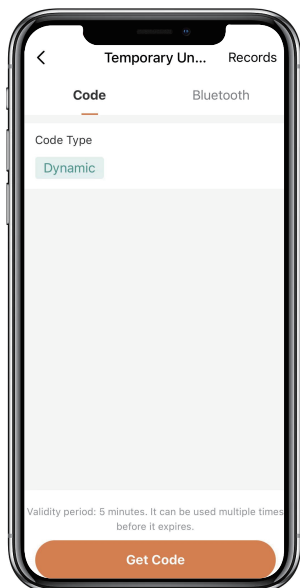

How to add Members:

☒ Tap “Member Management” to add family member or others.

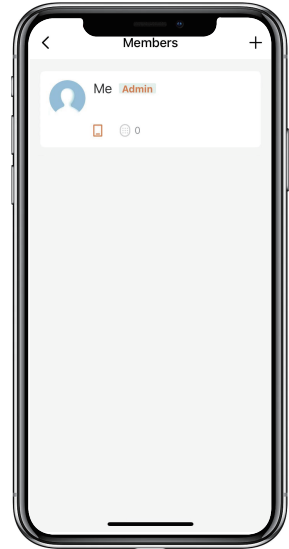
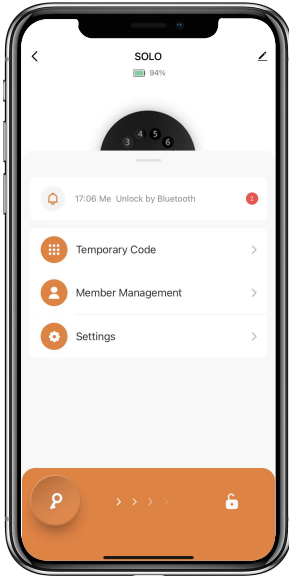

☒ Tap “+” to add member and edit member’s information and save.

☒ Member will receive an invitation on the App, after he/she accept it, Admin can find the member in the list.

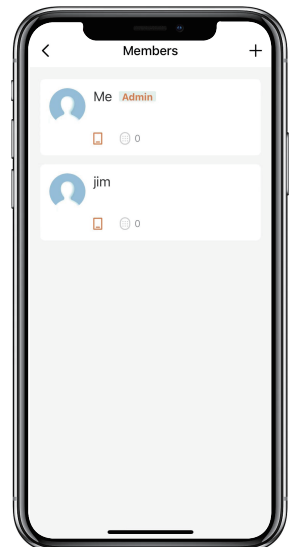
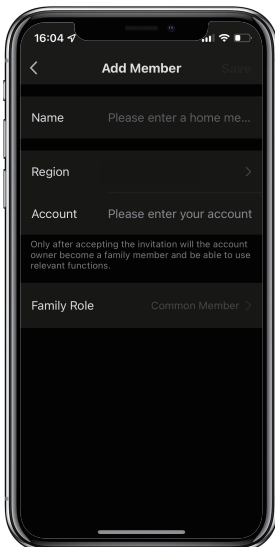

How to add Permanent code:

☑ Tap the Admin “Me” to add Permanent code.

☑ Tap “Add” to enter the Permanent code you want to set or get Random Permanent code and save.

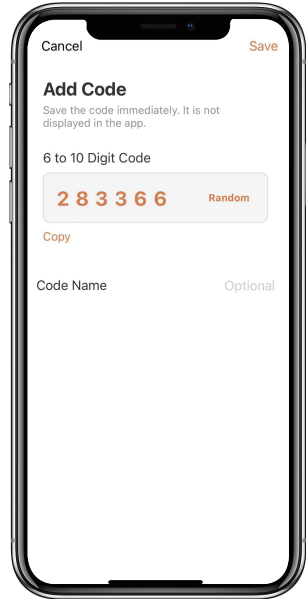
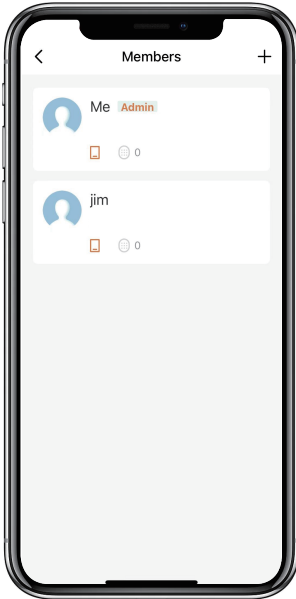

☑ You are able to use the Permanent code to unlock the device.

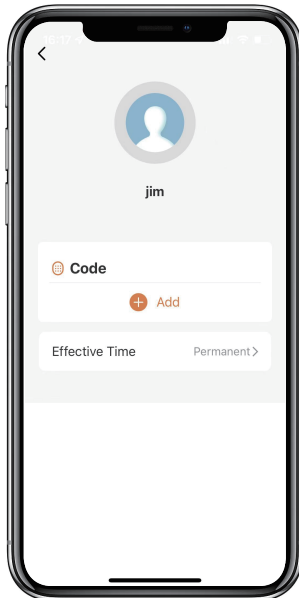

How to manage Members:

☒ Tap the Member you want to manage.

☒ Tap "Add" to set the Permanent code for the Member and save.

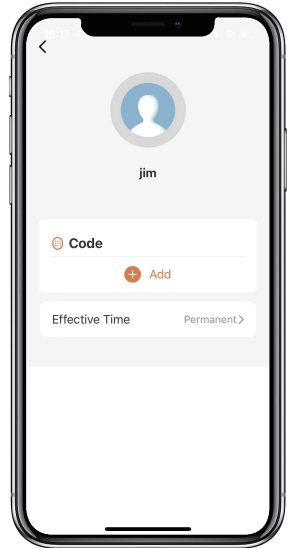
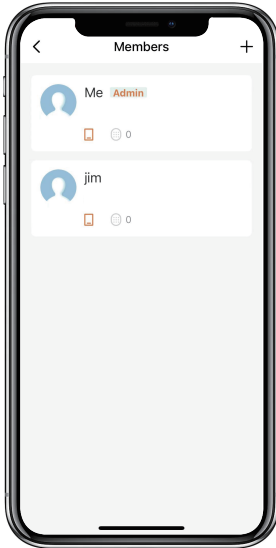

☒ Tap "Effective Time" to set this Member is Permanent or Custom and save.

☒ Set the validity period of Custom Member(Year/Month/Day/Hour/Minute).

☒ Members have no permission to access admin.

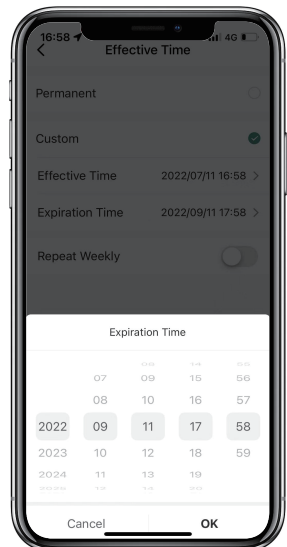
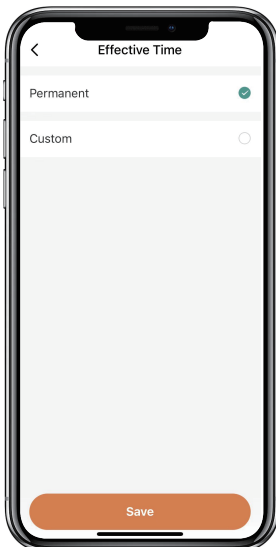

How to check Opening Log:

☒ Tap  to check the Log.

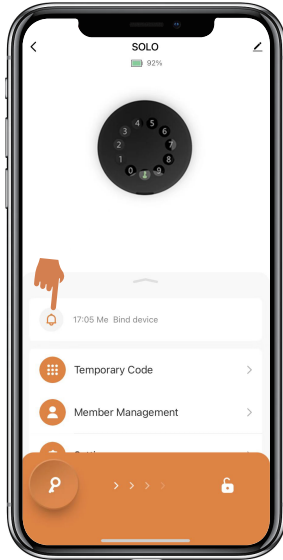

☒ You will find out when and whom opened the Keybox.

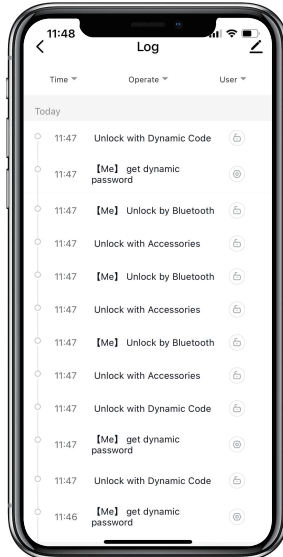

OMUARK
WWW.OMCONNECT.COM / WWW.OMUARK.COM